



And God said, Let there be light: and there was light.



Factory add: No.33 Xianxing road, Xianlin town, Yuhang district, Hangzhou, Zhejiang, China, 311122



2018

Leber LIGHT

HANGZHOU ZHETE ELECTRONICS CO.,LTD

milestone



2003

- Hangke Optoelectronics founded
- started white LED package

2008

- started SMD package:
SMD2835, SMD3014, SMD5630 etc

2010

- started filament R&D
- developed the 1st filament strip together with Zhejiang university



2013

- started filament production

2014

- got LM-80 certification of filament
- started filament bulb production
- started export business of filament bulb

2016

- Set up An'hui HangKe factory
- HKLED listed in stock market

2017-

- we are on the way

Remote control filament bulb



Product features

- controllable with effective distance 15m.
- 360° omnidirection beam angle.
- long lifespan with 15000hrs.
- high luminous efficiency.
- low power consumption.
- eco friendly.



Dimmable version 									
Bulb type	Finish	Voltage	Watt	Lumen	EQ Watt	CCT	CRI	Driver	Base
A60	clear	220-240V	4,0W	470 lm	40W	2700K/4000K/6500K	≥80	linear	E27/B22
A60	clear	220-240V	5,5W	600 lm	50W	2700K/4000K/6500K	≥80	linear	E27/B22

Certification Europe



coming soon

Bluetooth control filament bulb



Product features

- controllable with effective distance 15m.
- 360° omnidirection beam angle.
- long lifespan with 15000hrs.
- high luminous efficiency.
- low power consumption.
- eco friendly.



Dimmable version 									
Bulb type	Finish	Voltage	Watt	Lumen	EQ Watt	CCT	CRI	Driver	Base
A60	clear	220-240V	4,0W	470 lm	40W	2700K/4000K/6500K	≥80	linear	E27/B22
A60	clear	220-240V	5,5W	600 lm	50W	2700K/4000K/6500K	≥80	linear	E27/B22

Certification Europe





coming soon

Step dimming filament bulb 100% - 55% - 20%



Product features

	brightness	
 step 1		100%
	brightness	
 step 2		55%
	brightness	
 step 3		20%



Dimmable version 									
Bulb type	Finish	Voltage	Watt	Lumen	EQ Watt	CCT	CRI	Driver	Base
B35/BA35/G45/A60	clear	220-240V	4,0W	470 lm	40W	2700K/4000K/6500K	≥80	linear	E14/E27
A60	clear	220-240V	6,5W	806 lm	60W	2700K/4000K/6500K	≥80	linear	E27

Certification Europe



coming soon

High brightness filament bulb 2452 lm



Product features

- ultra bright with 2452 lm.
- 360° omnidirection beam angle.
- long lifespan with 15000hrs.
- high luminous efficiency.
- low power consumption.
- eco friendly.

product size

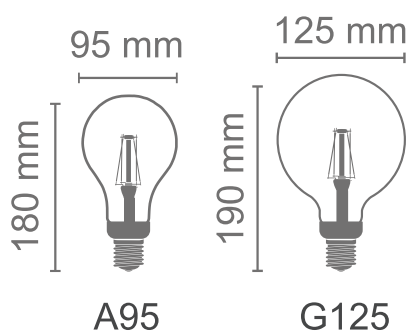

color ref



Non-dimmable version 									
Bulb type	Finish	Voltage	Watt	Lumen	EQ Watt	CCT	CRI	Driver	Base
A95	clear	220-240V	15W	2000 lm	125W	2700K/4000K/6500K	≥80	SMPS	E27/B22
G125	clear	220-240V	18W	2452 lm	150W	2700K/4000K/6500K	≥80	SMPS	E27/B22

Certification Europe



Glow dim filament bulb



Product features

- ultra bright and no flickering.
- 360° omnidirection beam angle.
- long lifespan with 15000hrs.
- high luminous efficiency.
- low power consumption.
- eco friendly.

range

CCT: min 1700K - max 6500K

lumen: min 90lm - max 806lm



Glow dim filament bulb



Dimmable version 									
Bulb type	Finish	Voltage	Watt	Lumen	EQ Watt	CCT	CRI	Driver	Base
B35/BA35/G45	clear	220-240V	5,0W	470 lm	40W	1700K - 6500K	≥80	SMPS	E14
B35/BA35/G45/A60	clear	220-240V	5,0W	470 lm	40W	1700K - 6500K	≥80	SMPS	E27
A60	clear	220-240V	7,0W	806 lm	60W	1700K - 6500K	≥80	SMPS	E27

Certification Europe



glow dim performance example

Dimmer:SIEMENS 5TC8 284

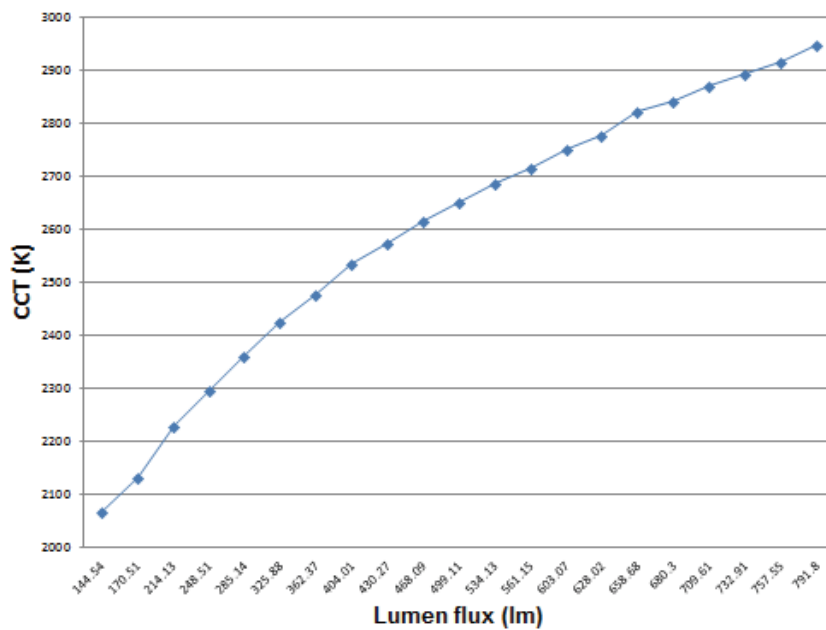

B35 filament bulb



Product features

- ultra bright and no flickering.
- 360° omnidirection beam angle.
- long lifespan with 15000hrs.
- high luminous efficiency.
- low power consumption.
- eco friendly.

option



clear



amber



milky



twisted

product size

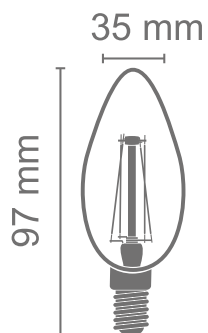



color ref



B35 filament bulb



Non-dimmable version 									
Bulb type	Finish	Voltage	Watt	Lumen	EQ Watt	CCT	CRI	Driver	Base
B35	clear	220-240V	1,6W	136 lm	15W	2700K/4000K/6500K	≥80	linear	E14/E27/B15/B22
B35	clear	220-240V	2,8W	250 lm	25W	2700K/4000K/6500K	≥80	linear	E14/E27/B15/B22
B35	clear	220-240V	4,0W	470 lm	40W	2700K/4000K/6500K	≥80	linear	E14/E27/B15/B22
Dimmable version 									
Bulb type	Finish	Voltage	Watt	Lumen	EQ Watt	CCT	CRI	Driver	Base
B35	clear	220-240V	2,8W	250 lm	25W	2700K/4000K/6500K	≥80	linear	E14/E27/B15/B22
B35	clear	220-240V	4,0W	470 lm	40W	2700K/4000K/6500K	≥80	linear	E14/E27/B15/B22

Certification Europe



Dimmable version 									
Bulb type	Finish	Voltage	Watt	Lumen	EQ Watt	CCT	CRI	Driver	Base
B11	clear	120V	4,0W	300 lm	40W	2700K/5000K	≥80	linear	E12/E26
B11	clear	120V	5,5W	500 lm	60W	2700K/5000K	≥80	linear	E12/E26

Certification Northern America



BA35 filament bulb



Product features

- ultra bright and no flickering.
- 360° omnidirection beam angle.
- long lifespan with 15000hrs.
- high luminous efficiency.
- low power consumption.
- eco friendly.

option



clear



amber



milky

product size

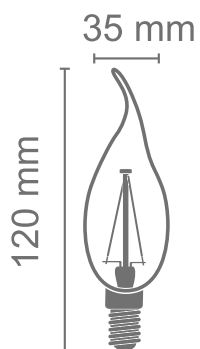



color ref



BA35 filament bulb



Non-dimmable version 									
Bulb type	Finish	Voltage	Watt	Lumen	EQ Watt	CCT	CRI	Driver	Base
BA35	clear	220-240V	1,6W	136 lm	15W	2700K/4000K/6500K	≥80	linear	E14/E27/B15/B22
BA35	clear	220-240V	2,8W	250 lm	25W	2700K/4000K/6500K	≥80	linear	E14/E27/B15/B22
BA35	clear	220-240V	4,0W	470 lm	40W	2700K/4000K/6500K	≥80	linear	E14/E27/B15/B22
Dimmable version 									
Bulb type	Finish	Voltage	Watt	Lumen	EQ Watt	CCT	CRI	Driver	Base
BA35	clear	220-240V	2,8W	250 lm	25W	2700K/4000K/6500K	≥80	linear	E14/E27/B15/B22
BA35	clear	220-240V	4,0W	470 lm	40W	2700K/4000K/6500K	≥80	linear	E14/E27/B15/B22

Certification Europe



Dimmable version 									
Bulb type	Finish	Voltage	Watt	Lumen	EQ Watt	CCT	CRI	Driver	Base
BA11	clear	120V	4,0W	300 lm	40W	2700K/5000K	≥80	linear	E12/E26
BA11	clear	120V	5,5W	500 lm	60W	2700K/5000K	≥80	linear	E12/E26

Certification Northern America



G45 filament bulb



Product features

- ultra bright and no flickering.
- 360° omnidirection beam angle.
- long lifespan with 15000hrs.
- high luminous efficiency.
- low power consumption.
- eco friendly.

option



clear



amber



milky



silver crown

product size

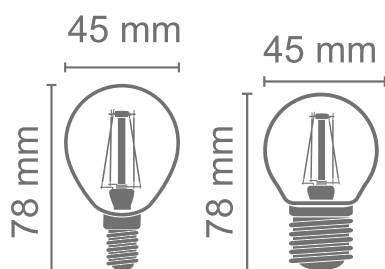



color ref



G45 filament bulb



Non-dimmable version 									
Bulb type	Finish	Voltage	Watt	Lumen	EQ Watt	CCT	CRI	Driver	Base
G45	clear	220-240V	1,6W	136 lm	15W	2700K/4000K/6500K	≥80	linear	E14/E27/B15/B22
G45	clear	220-240V	2,8W	250 lm	25W	2700K/4000K/6500K	≥80	linear	E14/E27/B15/B22
G45	clear	220-240V	4,0W	470 lm	40W	2700K/4000K/6500K	≥80	linear	E14/E27/B15/B22
Dimmable version 									
Bulb type	Finish	Voltage	Watt	Lumen	EQ Watt	CCT	CRI	Driver	Base
G45	clear	220-240V	2,8W	250 lm	25W	2700K/4000K/6500K	≥80	linear	E14/E27/B15/B22
G45	clear	220-240V	4,0W	470 lm	40W	2700K/4000K/6500K	≥80	linear	E14/E27/B15/B22

Certification Europe



Dimmable version 									
Bulb type	Finish	Voltage	Watt	Lumen	EQ Watt	CCT	CRI	Driver	Base
G16.5	clear	120V	3,5W	250 lm	25W	2700K/5000K	≥80	linear	E12/E26
G16.5	clear	120V	4,5W	350 lm	40W	2700K/5000K	≥80	linear	E12/E26
G16.5	clear	120V	5,5W	500 lm	60W	2700K/5000K	≥80	linear	E12/E26

Certification Northern America



A60 filament bulb



Product features

- ultra bright and no flickering.
- 360° omnidirection beam angle.
- long lifespan with 15000hrs.
- high luminous efficiency.
- low power consumption.
- eco friendly.

option



clear



amber



milky



silver crown

product size

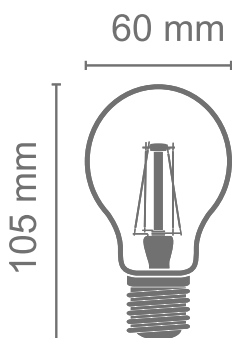

color ref



A60 filament bulb



Non-dimmable version 									
Bulb type	Finish	Voltage	Watt	Lumen	EQ Watt	CCT	CRI	Driver	Base
A60	clear	220-240V	4,0W	470 lm	40W	2700K/4000K/6500K	≥80	linear	E27/B22
A60	clear	220-240V	7,0W	806 lm	60W	2700K/4000K/6500K	≥80	linear	E27/B22
A60	clear	220-240V	8,0W	1055 lm	75W	2700K/4000K/6500K	≥80	SMPS	E27/B22
A60	clear	220-240V	11,0W	1521 lm	100W	2700K/4000K/6500K	≥80	SMPS	E27/B22

Dimmable version 									
Bulb type	Finish	Voltage	Watt	Lumen	EQ Watt	CCT	CRI	Driver	Base
A60	clear	220-240V	4,0W	470 lm	40W	2700K/4000K/6500K	≥80	linear	E27/B22
A60	clear	220-240V	6,5W	806 lm	60W	2700K/4000K/6500K	≥80	SMPS	E27/B22
A60	clear	220-240V	8,5W	1055 lm	75W	2700K/4000K/6500K	≥80	SMPS	E27/B22

Certification Europe



Dimmable version 									
Bulb type	Finish	Voltage	Watt	Lumen	EQ Watt	CCT	CRI	Driver	Base
A19	clear	120V	6,0W	500 lm	40W	2700K/5000K	≥80	linear	E26
A19	clear	120V	8,0W	800 lm	60W	2700K/5000K	≥80	SMPS	E26

Certification Northern America



G80/G95/G125 filament bulb



Product features

- ultra bright and no flickering.
- 360° omnidirection beam angle.
- long lifespan with 15000hrs.
- high luminous efficiency.
- low power consumption.
- eco friendly.

option



clear



amber



milky



silver crown



green crown



gold crown



rose crown



black crown

product size

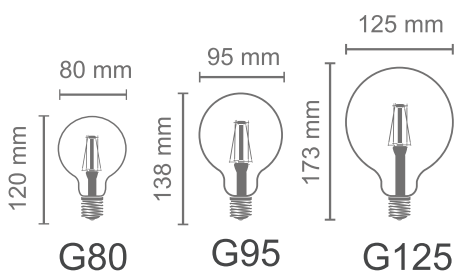



color ref



G80/G95/G125 filament bulb



Non-dimmable version 									
Bulb type	Finish	Voltage	Watt	Lumen	EQ Watt	CCT	CRI	Driver	Base
G80/G95/G125	clear	220-240V	4,0W	470 lm	40W	2700K/4000K/6500K	≥80	linear	E27/B22
G80/G95/G125	clear	220-240V	7,0W	806 lm	60W	2700K/4000K/6500K	≥80	linear	E27/B22
G80/G95/G125	clear	220-240V	8,0W	1055 lm	75W	2700K/4000K/6500K	≥80	SMPS	E27/B22
G80/G95/G125	clear	220-240V	11,0W	1521 lm	100W	2700K/4000K/6500K	≥80	SMPS	E27/B22
Dimmable version 									
Bulb type	Finish	Voltage	Watt	Lumen	EQ Watt	CCT	CRI	Driver	Base
G80/G95/G125	clear	220-240V	4,0W	470 lm	40W	2700K/4000K/6500K	≥80	linear	E27/B22
G80/G95/G125	clear	220-240V	6,5W	806 lm	60W	2700K/4000K/6500K	≥80	SMPS	E27/B22
G80/G95/G125	clear	220-240V	8,5W	1055 lm	75W	2700K/4000K/6500K	≥80	SMPS	E27/B22

Certification Europe



Dimmable version 									
Bulb type	Finish	Voltage	Watt	Lumen	EQ Watt	CCT	CRI	Driver	Base
G25/G30/G40	clear	120V	3,5W	250 lm	25W	2700K/5000K	≥80	linear	E26
G25/G30/G40	clear	120V	4,5W	350 lm	40W	2700K/5000K	≥80	linear	E26
G25/G30/G40	clear	120V	5,5W	500 lm	60W	2700K/5000K	≥80	linear	E26
G25/G30/G40	clear	120V	6,0W	575 lm	75W	2700K/5000K	≥80	SMPS	E26
G25/G30/G40	clear	120V	6,5W	650 lm	100W	2700K/5000K	≥80	SMPS	E26

Certification Northern America



ST64 filament bulb



Product features

- ideal bulb for decoration.
- 360° omnidirection beam angle.
- long lifespan with 15000hrs.
- high luminous efficiency.
- low power consumption.
- eco friendly.

option



clear



amber

product size

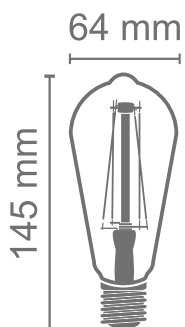



color ref



ST64 filament bulb



Non-dimmable version 									
Bulb type	Finish	Voltage	Watt	Lumen	EQ Watt	CCT	CRI	Driver	Base
ST64	clear	220-240V	4,0W	470 lm	40W	2700K/4000K/6500K	≥80	linear	E27/B22
ST64	clear	220-240V	7,0W	806 lm	60W	2700K/4000K/6500K	≥80	linear	E27/B22
ST64	amber	220-240V	4,0W	380 lm	—	2400K	≥80	linear	E27/B22
ST64	amber	220-240V	7,0W	630 lm	—	2400K	≥80	linear	E27/B22

Dimmable version 									
Bulb type	Finish	Voltage	Watt	Lumen	EQ Watt	CCT	CRI	Driver	Base
ST64	clear	220-240V	4,0W	470 lm	40W	2700K/4000K/6500K	≥80	linear	E27/B22
ST64	clear	220-240V	6,5W	806 lm	60W	2700K/4000K/6500K	≥80	SMPS	E27/B22
ST64	amber	220-240V	4,0W	380 lm	—	2400K	≥80	linear	E27/B22
ST64	amber	220-240V	6,5W	630 lm	—	2400K	≥80	SMPS	E27/B22

Certification Europe



Dimmable version 									
Bulb type	Finish	Voltage	Watt	Lumen	EQ Watt	CCT	CRI	Driver	Base
ST21	clear	120V	4,0W	300 lm	40W	2700K/5000K	≥80	linear	E26
ST21	clear	120V	5,5W	500 lm	60W	2700K/5000K	≥80	linear	E26

Certification Northern America



R50/R63/R80 filament bulb

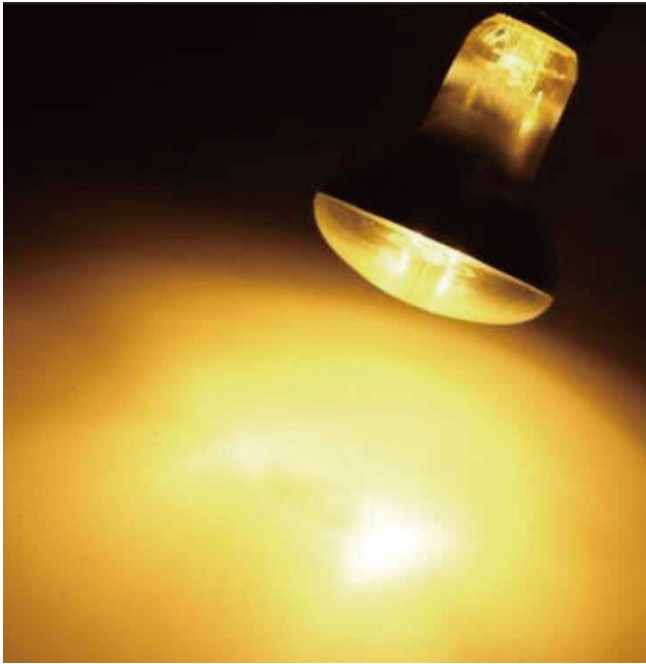

Product features

- no flickering.
- long lifespan with 15000hrs.
- high luminous efficiency.
- low power consumption.
- eco friendly.

option



R50



R63



R80

product size

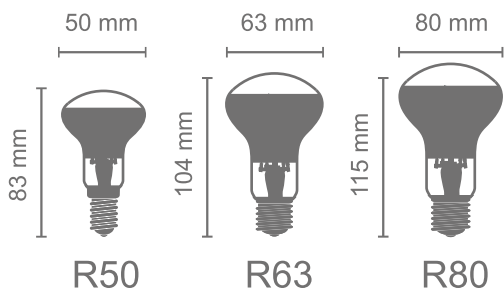

color ref



R50/R63/R80 filament bulb



Non-dimmable version 								
Bulb type	Finish	Voltage	Watt	Lumen	CCT	CRI	Driver	Base
R50	silver	220-240V	1,6W	110 lm	2700K/4000K/6500K	≥80	linear	E14/B15
R50	silver	220-240V	2,8W	180 lm	2700K/4000K/6500K	≥80	linear	E14/B15
R63	silver	220-240V	2,8W	180 lm	2700K/4000K/6500K	≥80	linear	E27/B22
R63	silver	220-240V	4,0W	380 lm	2700K/4000K/6500K	≥80	linear	E27/B22
R80	silver	220-240V	4,0W	380 lm	2700K/4000K/6500K	≥80	linear	E27/B22
R80	silver	220-240V	7,0W	620 lm	2700K/4000K/6500K	≥80	linear	E27/B22

Certification Europe



T25/T28 filament bulb



Product features

- widely used for decoration.
- 360° omnidirection beam angle.
- long lifespan with 15000hrs.
- high luminous efficiency.
- low power consumption.
- eco friendly.

option



product size

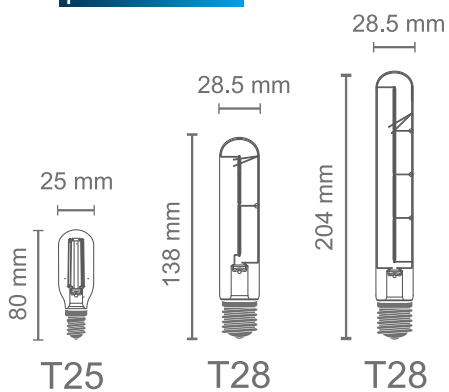

color ref



T25/T28 filament bulb



Non-dimmable version 									
Bulb type	Finish	Voltage	Watt	Lumen	EQ Watt	CCT	CRI	Driver	Driver
T25	clear	220-240V	1,6W	136 lm	15W	2700K/4000K/6500K	≥80	linear	E14/B15
T25	clear	220-240V	2,8W	250 lm	25W	2700K/4000K/6500K	≥80	linear	E14/B15
T25	clear	220-240V	4,0W	470 lm	40W	2700K/4000K/6500K	≥80	linear	E14/B15
T28	clear	220-240V	2,8W	250 lm	25W	2700K/4000K/6500K	≥80	linear	E27/B22
T28	clear	220-240V	4,0W	470 lm	40W	2700K/4000K/6500K	≥80	linear	E27/B22

Dimmable version 									
Bulb type	Finish	Voltage	Watt	Lumen	EQ Watt	CCT	CRI	Driver	Base
T25	clear	220-240V	2,8W	250 lm	25W	2700K/4000K/6500K	≥80	linear	E14/B15
T25	clear	220-240V	4,0W	470 lm	40W	2700K/4000K/6500K	≥80	linear	E14/B15
T28	clear	220-240V	2,8W	250 lm	25W	2700K/4000K/6500K	≥80	linear	E27/B22
T28	clear	220-240V	4,0W	470 lm	40W	2700K/4000K/6500K	≥80	linear	E27/B22

Certification Europe



Dimmable version 									
Bulb type	Finish	Voltage	Watt	Lumen	EQ Watt	CCT	CRI	Driver	Base
T9	clear	120V	2,5W	150 lm	25W	2700K/5000K	≥80	linear	E26
T9	clear	120V	4,0W	300 lm	40W	2700K/5000K	≥80	linear	E26

Certification Northern America



S26/S45 filament bulb



Product features

- classical incandescent bulb design.
- 360° omnidirection beam angle.
- high luminous efficiency.
- low power consumption.
- eco friendly.

option



S26 / clear



S45 / clear



S45 / amber

product size

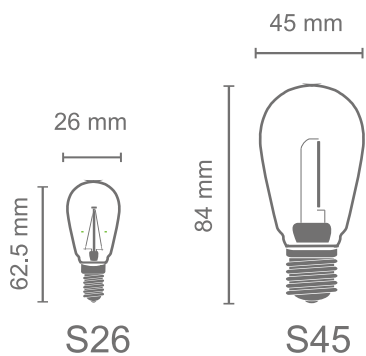



color ref



S26/S45 filament bulb



Non-dimmable version 									
Bulb type	Finish	Voltage	Watt	Lumen	EQ Watt	CCT	CRI	Driver	Base
S26	clear	220-240V	1,3W	110 lm	—	2700K/4000K/6500K	≥80	RC	E14/B15
S45	clear	220-240V	1,6W	136 lm	15W	2700K/4000K/6500K	≥80	linear	E14/E27/B15/B22
S45	clear	220-240V	2,8W	250 lm	25W	2700K/4000K/6500K	≥80	linear	E14/E27/B15/B22
S45	clear	220-240V	4,0W	470 lm	40W	2700K/4000K/6500K	≥80	linear	E14/E27/B15/B22
Dimmable version 									
Bulb type	Finish	Voltage	Watt	Lumen	EQ Watt	CCT	CRI	Driver	Base
S45	clear	220-240V	2,8W	250 lm	25W	2700K/4000K/6500K	≥80	linear	E14/E27/B15/B22
S45	clear	220-240V	4,0W	470 lm	40W	2700K/4000K/6500K	≥80	linear	E14/E27/B15/B22

Certification Europe



Non-dimmable version 									
Bulb type	Finish	Voltage	Watt	Lumen	EQ Watt	CCT	CRI	Driver	Base
S14	amber	120V	1,5W	90 lm	15W	2200K	≥80	linear	E26

Certification Northern America



Decorative filament bulb



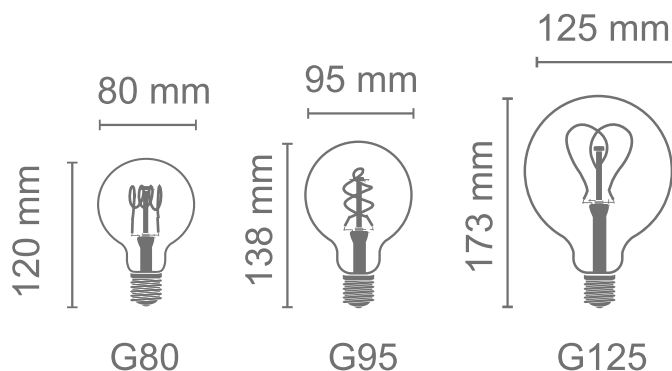

product size



option



Non-dimmable version 								
Bulb type	Finish	Voltage	Watt	Lumen	CCT	CRI	Driver	Base
G80/G95/G125	amber	220-240V	4,0W	250 lm	2000K	80	linear	E27/B22
Dimmable version 								
Bulb type	Finish	Voltage	Watt	Lumen	CCT	CRI	Driver	Base
G80/G95/G125	amber	220-240V	4,0W	250 lm	2000K	80	linear	E27/B22

Certification Europe



remark

* for more filament shapes and bulb types, please contact with our sales to get information in detail

Decorative filament bulb



product size

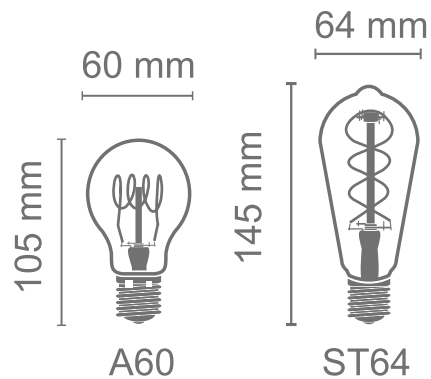

option



A60



A60





ST64



ST64



Non-dimmable version 								
Bulb type	Finish	Voltage	Watt	Lumen	CCT	CRI	Driver	Base
ST64	amber	220-240V	4,0W	250 lm	2000K	80	linear	E27/B22
A60	amber	220-240V	4,0W	250 lm	2000K	80	linear	E27/B22
Dimmable version 								
Bulb type	Finish	Voltage	Watt	Lumen	CCT	CRI	Driver	Base
ST64	amber	220-240V	4,0W	250 lm	2000K	80	linear	E27/B22
A60	amber	220-240V	4,0W	250 lm	2000K	80	linear	E27/B22

Certification Europe



remark

* for more filament shapes and bulb types, please contact with our sales to get information in detail

Decorative filament bulb



product size

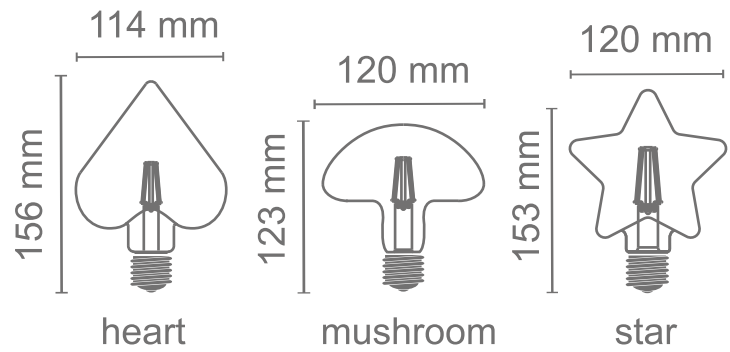

type



heart



mushroom



star



Non-dimmable version 							
Bulb type	Finish	Voltage	Watt	Lumen	CCT	Driver	Base
heart	amber	220-240V	2,8W	200 lm	2500K	linear	E27/B22
mushroom	amber	220-240V	2,8W	200 lm	2500K	linear	E27/B22
star	amber	220-240V	2,8W	200 lm	2500K	linear	E27/B22

Certification Europe



remark

* for more bulb types, please contact with our sales to get information in detail

Decorative filament bulb



product size

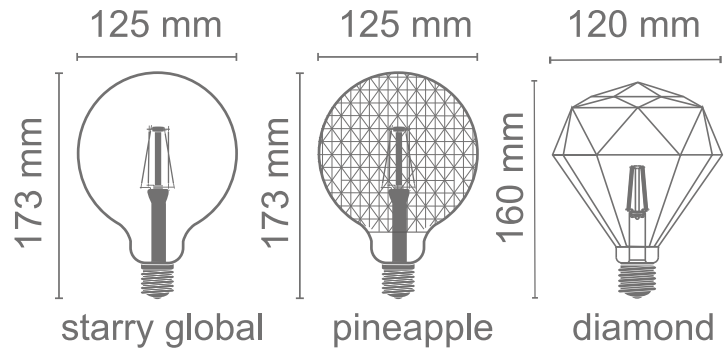

type



starry global



pineapple



diamond



Non-dimmable version 							
Bulb type	Finish	Voltage	Watt	Lumen	CCT	Driver	Base
starry global	multicolor	220-240V	2,8W	20 lm	multicolor	linear	E27/B22
pineapple	amber	220-240V	2,8W	200 lm	2500K	linear	E27/B22
diamond	amber	220-240V	2,8W	200 lm	2500K	linear	E27/B22

Certification Europe



remark

* for more bulb types, please contact with our sales to get information in detail